

GET THE MOST FROM YOUR BASEMENT DOOR!

Meets International Residential Code (IRC2021)

- Heavy Duty Steel
- Galvanized Sill
- Stainless Steel Hinge
- One Piece Header
- All units are painted with a rust inhibitive primer ready to be painted
- Additional sizes available

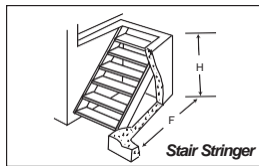
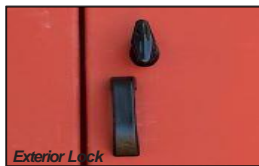
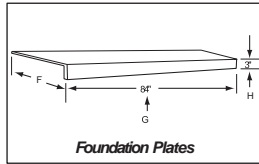
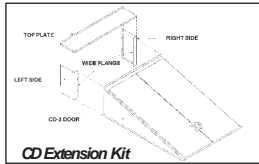

CD Model

CD-MODEL

For Existing Flat Foundations and New Construction

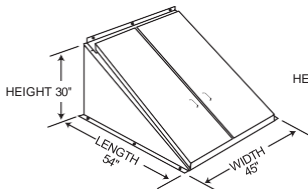

MODEL CD-0

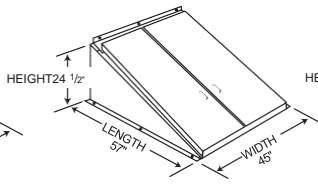

MODEL CD-1

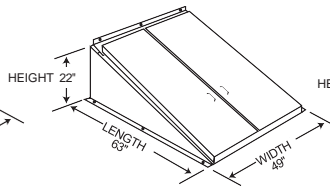

MODEL CD-2

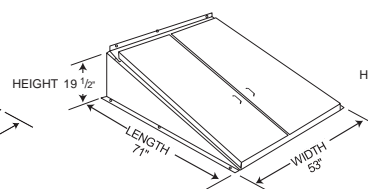

MODEL CD-3

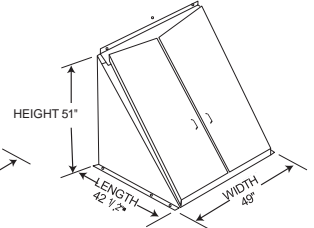

MODEL CD-SL

NOTE: Dimensions shown are outside frame dimensions.

HOW TO SELECT DOOR WITH SIDES

1. Measure dimensions A, B, C, D and K.
2. Select length at least 2" longer than "A" and no longer than "B".
3. Select width at least 4" wider than "C" and no wider than "D".
4. Check to make sure the height of the model selected is greater than "K". The "K" dimension is the distance from the top of the foundation to the top of basement door opening, not the height of your old door.

A=..... C=.....
 B=..... D=.....
 K=.....

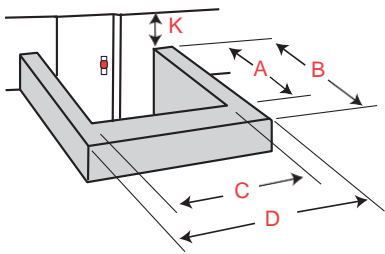

| | OUTSIDE FRAME DIMENSIONS | | | | | CD-3 WITH EXTENSIONS* | | | | |
|---------------|--------------------------|------|---------|------|---------|-----------------------|--------|--------|--------|--------|
| MODEL | CD-SL | CD-0 | CD-1 | CD-2 | CD-3 | CX-6" | CX-12" | CX-18" | CX-24" | CX-30" |
| LENGTH | 42 1/2" | 54" | 57" | 63" | 71" | 77" | 83" | 89" | 95" | 101" |
| WIDTH | 49" | 45" | 45" | 49" | 53" | 53" | 53" | 53" | 53" | 53" |
| HEIGHT | 51" | 30" | 24 1/2" | 22" | 19 1/2" | 21" | 21" | 21" | 21" | 21" |

*NOTE: Only CD-3 can be extended. If standard sizes and extensions do not fulfill the foundation requirements please call 860-628-4775 for guidance.



Made in USA

GET THE MOST FROM YOUR BASEMENT DOOR!

- Heavy Duty Steel
- Galvanized Sill
- Stainless Steel Hinge
- One Piece Header
- All units are painted with a rust inhibitive primer ready to be painted
- Additional sizes available

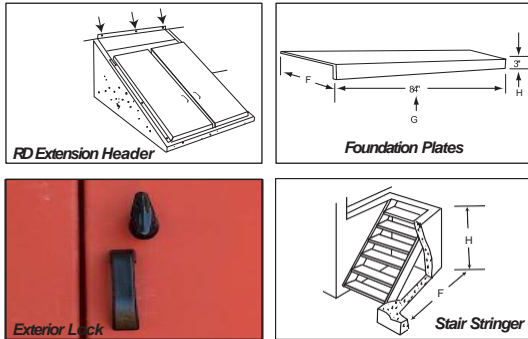

RD Model

RD-MODEL

Replacement Doors for Sloping Foundations

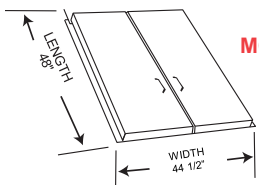

MODEL RD-0

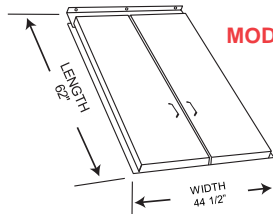

MODEL RD-1

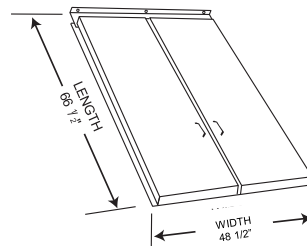

MODEL RD-2

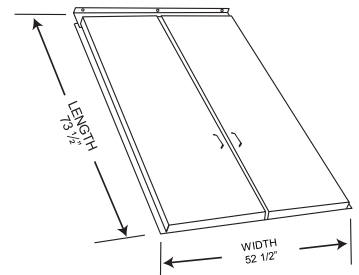

MODEL RD-3

NOTE: Dimensions shown are outside frame dimensions.

HOW TO SELECT A DOOR WITHOUT METAL SIDES

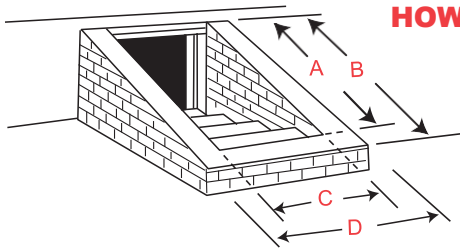

1. Measure dimensions **A**, **B**, **C** and **D**.
2. Select length at least 2" longer than "A" and no longer than "B".
3. Select width at least 4" wider than "C" and no wider than "D".

| | |
|---------|---------|
| A=..... | C=..... |
| B=..... | D=..... |

| MODEL | WIDTH | LENGTH | WITH 6" EXTENSION | WITH 12" EXTENSION | WITH 18" EXTENSION | IF LONGER LENGTHS ARE REQUIRED, ORDER FLAT STEEL FROM THE PLANT |
|---------------------------------|---------|---------|---|--------------------|--------------------|---|
| RD-0 | 44 1/2" | 48" | 53"-55" X1-6 | 59"-61" X1-12 | NA | |
| RD-1 | 44 1/2" | 62" | 67"-69" X1-6 | 73"-75" X1-12 | NA | |
| RD-2 | 48 1/2" | 66 1/2" | 71"-73" X2-6 | 77"-79" X2-12 | NA | |
| RD-3 | 52 1/2" | 73 1/2" | 78"-80" X3-6 | 84"-86" X3-12 | 90"-92" X3-18 | |
| OUTSIDE FRAME DIMENSIONS | | | EXTENSION HEADERS ARE NOT INCLUDED IN DOORS – ORDER SEPARATELY | | | |

